

**SPANNFIX ECO
CMM START-KIT M610**

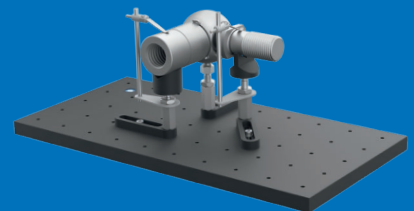
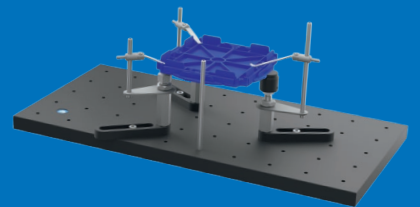
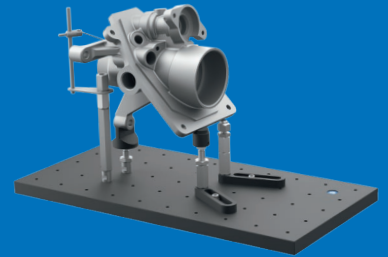
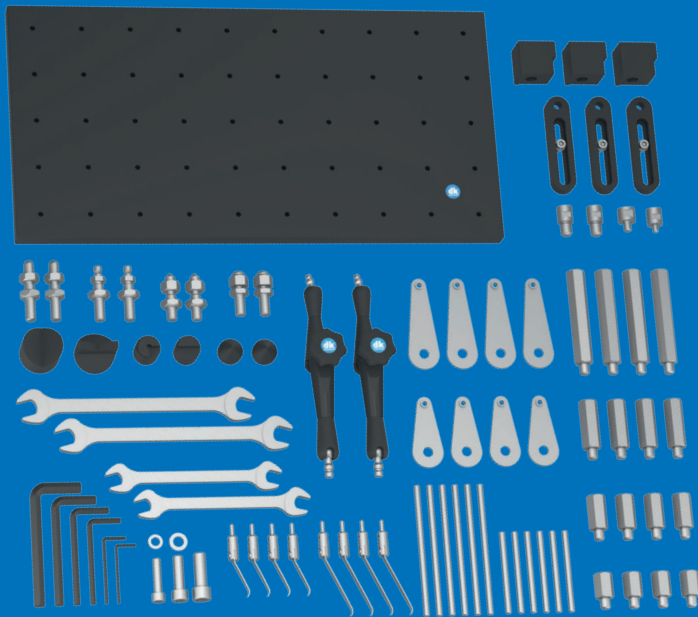

Clamping device set SPANNFIX ECO CMM Start-Kit M610

Precision due to flat and distortion-free baseplate and soundly dimensioned M10 main columns.

Durability due to high-strength aluminium with Hardcoat coating and stainless steel structural components.

Universal Start-Kit through intelligent set formation. Perfectly expandable using many other standard parts from the SPANNFIX ECO catalogue range

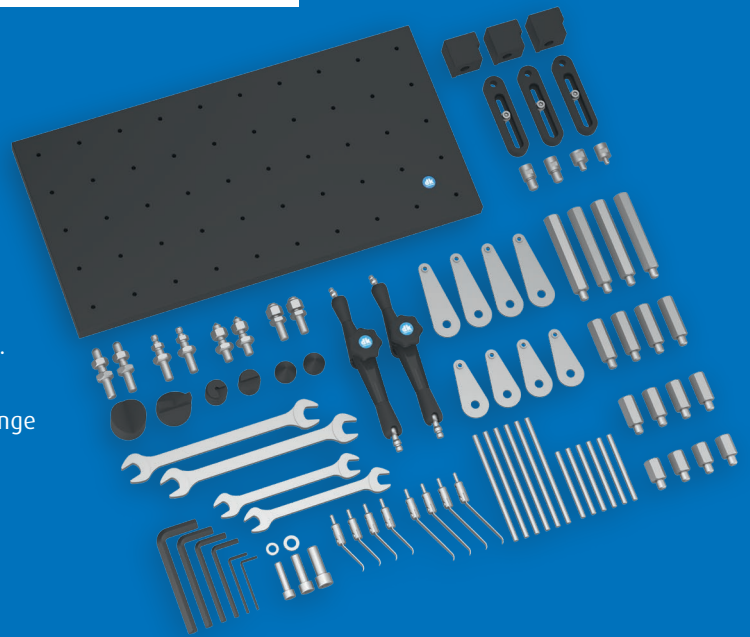

Application examples

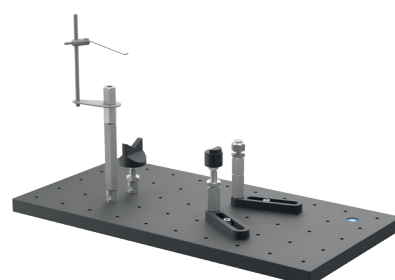
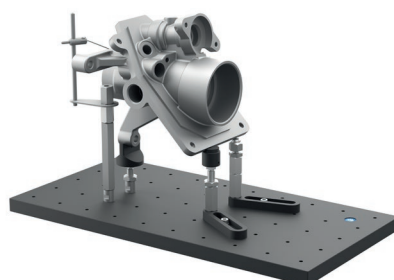
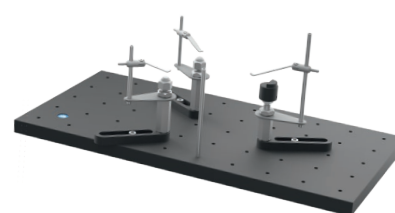
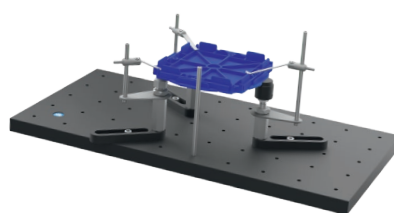

Maximum modularity for optimum application flexibility

SPANNFIX ECO - More value through combinability with other dk module programs

What are the overriding advantages of the vigorously pursued system mindset? What do individual users, the entire QA and adjacent parts of a company gain from investing in modular programs that can be expanded and combined almost at will?

- » Basic, structural, manipulation, clamping and retaining elements that can be used with different workpieces, machines and processes.
- » Quick-change systems that enable the variable use of clamping elements on different metrology machines and thus reduce costs
- » Manufacturing program with so many and extensive fixation systems that only one supplier is needed for all requirements in measuring and testing technology, as well as in laser and handling technology
- » Custom-made products, which are becoming less and less necessary as a result of the many parts available in the catalogue and - if they are unavoidable - are being produced more cost-effectively.

Use together with **SPANNFIX PRO**

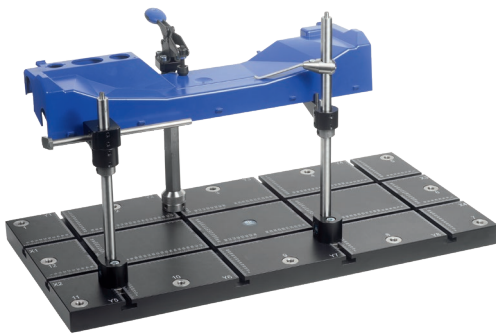

Use of the Start Kit on a **QUADERFIX** plate

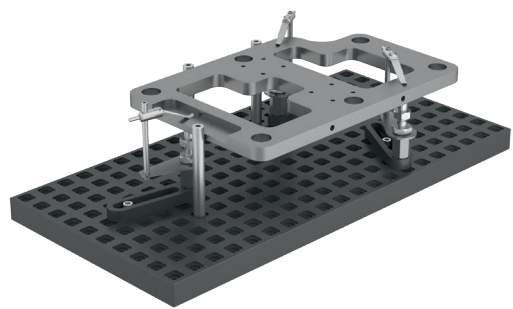

As "Quick-Set" combined with the **dk-articulated joint system**



SWA39 system and **NADELFIX** on **SPANNFIX ECO** baseplate

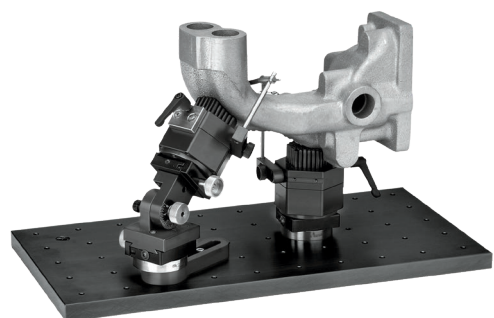

SPANNFIX ECO - CMM Start-Kit M610

Order number 285180

1

SPANNFIX ECO baseplate

Description	Quantity	Order No.
Baseplate M6, hole grid 50 mm, WxDxH 500x250x20 mm	1	395030

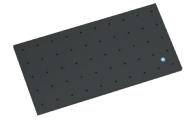

2

Clamping claws

Description	Quantity	Order No.
Clamping claws for M8, m10 and M12 threads	3	281440



3

Base rail M10

Description	Quantity	Order No.
Base rail 105 mm with M6 screw for baseplate	3	322010



4

Thread reducer

Description	Quantity	Order No.
M6 male / M8 female for 3D central clamping joint	2	275000
M6 male / M10 female for hex columns	2	275010
SWA8 male / M6 female for 3D central clamping joint	2	246411



5

Hex columns M10, AF 17

Description	Quantity	Order number
25 mm	4	322200
35 mm	4	322300
50 mm	4	322400
100 mm	4	304400



6

Quick-change mount M 10/SWA 8

Description	Quantity	Order No.
Quick-change adapter M 10 for SWA8 modules	2	329500



7

SWA8 centre

Description	Quantity	Order No.
90° centres with SWA8 quick-change adapter, Ø25 mm	2	303700



8

Flat support SWA8

Description	Quantity	Order No.
Flat support, straight stop, SWA8	1	303810
Flat support, corner stop, SWA8	1	303815



9

Prism support SWA8

Description	Quantity	Order No.
40 mm, SWA8	1	323400
8 mm, SWA8	1	323500



10

Self-aligning pads M10

Description	Quantity	Order No.
To compensate for form inclinations ± 15°	2	323000



SPANNFIX ECO - CMM Start-Kit M610 (continued)

Order number: 285180

11 Screw jacks M10

Description	Quantity	Order No.
With 90° cone point, Ø10	2	322600
With 5 mm tip radius	2	322700



12 Adapter plate for M6 columns

Description	Quantity	Order No.
50 mm, for mounting on M10 columns, pendulum, form and quick-change adapters	4	353700
75 mm, for mounting on M10 columns, pendulum, form and quick-change adapters	4	353800



13 Ø6 column with M6 thread

Description	Quantity	Order No.
75 mm, for spring finger or as stop, with hex socket	6	368300
125 mm, for spring finger or as stop, with hex socket	6	368500



14 Spring finger Ø 6

Description	Quantity	Order No.
50 mm, self-locking and individually adaptable	4	302800
75 mm, self-locking and individually adaptable	4	302900



15 3D central clamping joint

Description	Quantity	Order No.
Action radius 170 mm, threads M8 male under / M6 top	2	240011



16 Accessories

Description	Quantity
M8 x 30 screw for clamping claw	3
M10 x 30 screw for clamping claw	3
M12 x 30 screw for clamping claw	3
U-washer for M8 screw	3
U-washer for M10 screw	3
U-washer for M12 screw	3
AF 13/15 spanner	2
AF 17/19 spanner	2
2.5 mm hex key for SWA8	1
3 mm hex key for round columns	1
5 mm hex key for base rails	1
6 mm hex key for clamping claws	1
8 mm hex key for clamping claws	1
10 mm hex key for clamping claws	1

CMM START-KIT M610	285180
Total- 101 parts (plus sales tax, packaging and shipping)	Complete price 2.388 €

SPANNFIX ECO - CMM Start-Kit M609 (the alternative without clamping joint)

Order number: 285175

Clamping set 285180 without clamping joint (position 15) and associated adaptor (from position 4)

CMM START-KIT M609	285175
Total- 95 parts (plus sales tax, packaging and shipping)	Complete price 1.988 €



The digital version of our catalogue is available here:
www.dk-fixiersysteme.de

The entire world of fixating, clamping and positioning.

The ca. 1,000 parts of the comprehensive standard modular system of the dk fixation systems for measurement technology offers the following advantages:

- » Tried and tested modular system that has grown over decades
- » Modularity across different programs
- » Solutions for every positioning task
- » Economic efficiency through synergy effects of several sector solutions

SWA39

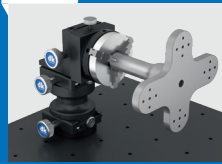

SPANNFIX PRO

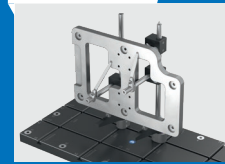

SPANNFIX ECO



QUADERFIX

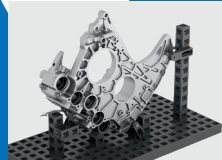

SCHIENENFIX



MICROFIX



SWA39CT



SPEZIALFIX

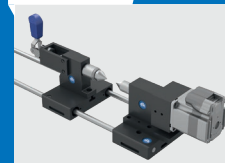

ARTICULAR SYSTEMS

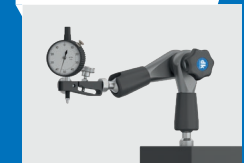

dk FIXIERSYSTEME GmbH & Co. KG
 Ferdinand-Lassalle-Strasse 35
 72770 Reutlingen, Germany

Tel. +49 (0) 7121 90 97 10
 Fax +49 (0) 7121 90 97 120
info@dk-fixiersysteme.de
www.dk-fixiersysteme.de

modular. simple. better.



**FAST
 REASSEMBLY
 LIFELONG**

The basic principle of all dk fixating systems!

Our modular fixtures can effortlessly be disassembled and precisely reassembled at any time. The compatibility of the fixturing systems make the utility value perfect.